

Lynx Plus Security System

Programming Guide

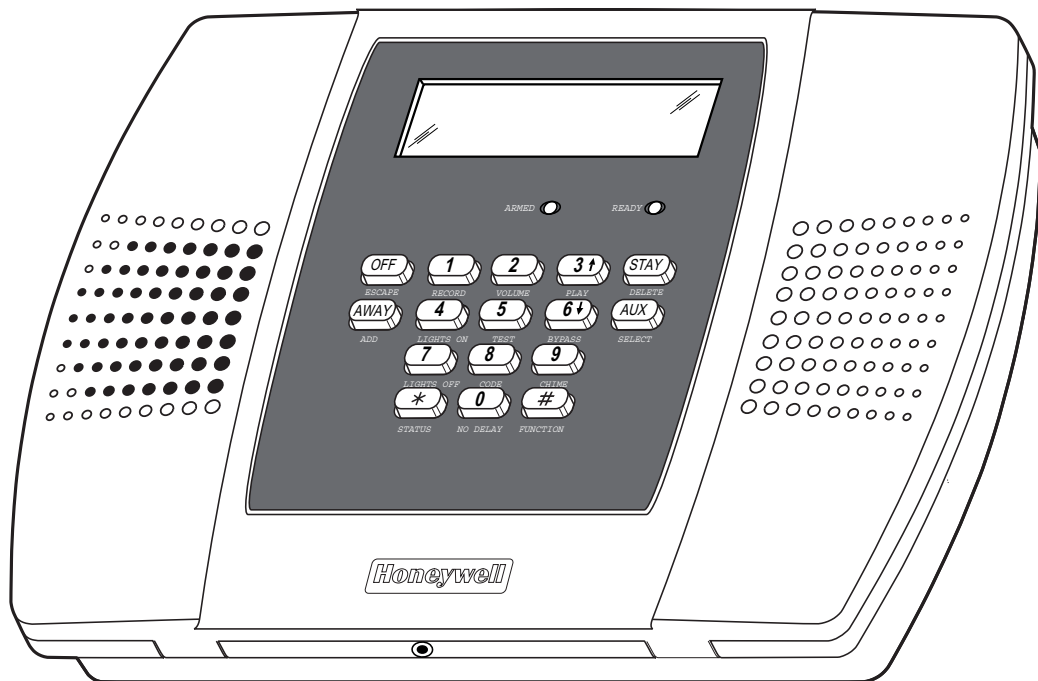

TABLE OF CONTENTS

Data Fields.....	3
*56 Enhanced Zone Programming.....	10
*56 Enhanced Zone Programming Worksheet.....	13
*80 Device Programming.....	15
*81 Zone Lists.....	16
Powerline Carrier Device Worksheet for *80 and *81.....	17
*83 Enhanced Sequential Mode.....	18
*84 Assign Zone Voice Descriptors.....	19
Vocabulary Index (for *84 Assign Zone Voice Descriptors).....	19
*85 Record Custom Voice Descriptors.....	20
5800 Series Transmitter Loop Numbers Diagram.....	21
Lynx Plus Summary of Connections Diagram.....	23

Refer to the Lynx Plus Series Installation and Setup Guide P/N 800-03858 or later for detailed information on programming the system. The Installation and Setup Guide contains full descriptions for all data fields.



Lynx Plus is not intended for UL985 Household Fire applications unless a 24-hour backup battery (P/N LYNXRCHKIT-HC or LYNXRCHKIT-SHA) is installed.

To Enter Programming Mode:



You may find it convenient to adjust the volume setting before entering the Programming Mode. This will allow you to clearly hear feedback announcements or system beeps.

1. Power up, then depress [*] and [#] both at once, within 50 seconds of powering up.

OR

Enter: Installer Code (4 + 1 + 1 + 2) plus 8 + 0 + 0. System will display "Entering Program Mode".

Notes: 1. If a different Installer Code has been programmed, enter: the New Installer Code + 8 + 0 + 0.

2. If *98 was previously used to exit programming, the first method shown above must be used to re-enter the program mode)

2. Upon entry into Program mode, data field "20 INSTALLER CODE" will be displayed (the first data field in the system) and both keypad LEDs will flash.

To Program the Data Fields:

1. Press [*] followed by the desired field number (e.g., *21), then make the required entry.
2. The keypad beeps three times after entering data, then displays the next data field in sequence.
3. For phone number and account number fields, press [*] to end the entry if less than number maximum number of digits is entered.
4. To view data entered in field, press [#] plus the field that you wish to view (e.g., #21). The system will beep three times and data programmed for that field will be displayed to the right of the field number. The system will scroll through the data for longer numbers and a beep will sound after each number is displayed or three times after the final digit is displayed.
5. To delete an entry, simply press [*] plus that field number and reenter the correct data. For phone number and account number fields *40-*44, *88 and *94, press [*] + field number + [*].

Interactive Menu Modes:

There are six interactive menu modes as listed below. To enter these modes, first enter Program mode. While in Program mode, press [*] plus the mode number desired (e.g., *56).

*56 Enhanced Zone Programming.....For programming zone characteristics, report codes, etc.

*80 Device Programming.....For programming Powerline Carrier Devices

*81 Zone List Programming.....For programming zone lists for use with Powerline Carrier Devices

*83 Enhanced Sequential Mode.....For entering transmitter serial numbers

*84 Assign Zone Voice Descriptors.....For assigning voice descriptors to zones

*85 Record Custom Voice Descriptors.....For recording custom voice descriptors

To Initialize Download ID and Subscriber Account Number for Downloading:

*96 Resets all subscriber account numbers and CSID in preparation for an initial download.

To Load a Default Set:

*97 Enter a number 1-4 corresponding to the selected default table (See the Installation Instructions for the default tables). Enter 0 if you are not selecting a default table.

To Exit Programming Mode:

- *98 Exits programming mode and *prevents* re-entry by: Installer Code + 8+ 0 + 0. If *98 is used to exit programming mode, system must be powered down, then press [*] and [#] within 50 seconds of power up to re-enter programming mode.
- *99 Exits programming mode and *allows* re-entry by: Installer Code + 8 + 0 + 0 or: Power-up, then press [*] and [#] within 50 seconds of power up.

DATA FIELDS

Data Field Display **Function& Programming Options** [] = Programmed Table 1 Default Values

SYSTEM SETUP (*20- *30) † Entering a number other than the one specified may give unpredictable results.

20 INSTALLER CODE	Installer Code <input type="text"/> <input type="text"/> <input type="text"/> <input type="text"/> [4112] Enter 4 digits, 0-9
21 QUICK ARM ENABLE	Quick Arm Enable <input type="checkbox"/> + [1] 0 = no; 1 = yes
22 KEYPAD BACKLIGHT	Keypad Backlight Timeout <input type="checkbox"/> [0] 0 = none (backlighting always on); 1 = backlight off after 10secs
23 FORCED BYPASS	Forced Bypass UL installations = 0 <input type="checkbox"/> + [0] 0 = none; 1 = bypass open zones
24 RF HOUSE ID CODE	RF House ID Code <input type="text"/> <input type="text"/> [00] 00 = disable all wireless keypad usage; 01-31 = 5804BD/5804BDV house ID
25 X10 HOUSE CODE	Powerline Carrier Device (X10) House ID <input type="checkbox"/> [0] 0 = A; 1 = B, 2 = C, 3 = D, 4 = E, 5 = F, 6 = G, 7 = H, 8 = I, 9 = J, #10 = K, #11 = L, #12 = M, #13 = N, #14 = O, #15 = P
26 CHIME BY ZONE	Chime By Zone <input type="checkbox"/> † [0] 0 = no; 1 = yes (program zones to chime on zone list 3)
27 CLOCK DISPLAY	Real Time Clock Display <input type="checkbox"/> † [1] 0 = no; 1 = yes, display time on keypad
29 DST MNTH STR/END	Daylight Saving Time Start/End Month <input type="text"/> <input type="text"/> [3, 11] Start End 1-9, #+10,#+11,#+12. Enter 0,0 if no daylight savings time used.

Data Field Display

Function & Programming Options

[] = Programmed Table 1 Default Values

<p>30 DST WEEK STR/END</p>	<p>Daylight Saving Time Start/End Weekend</p> <p><input type="checkbox"/> <input type="checkbox"/> [2,1]</p> <p>Start End</p> <p>0=disable; 1=first; 2=second; 3=third; 4=fourth; 5=last; 6=next to last; 7=third from last</p>
--	---

ZONE SOUNDS AND TIMING (*31– *39) † Entering a number other than the one specified may give unpredictable results.

<p>31 SINGLE ALARM SND</p>	<p>Single Alarm Sounding/Zone UL installations = 0</p> <p><input type="checkbox"/> † [0]</p> <p>0 = Alarm Sounding Per Zone will be the same as the Swinger Shutdown” set in field *92; 1 = yes, limit once per arming period (also applies to long range radio output if “0” is selected in *91 field)</p>
--	---

<p>32 FIRE SND TIMEOUT</p>	<p>Sounder Timeout</p> <p><input type="checkbox"/> † [0]</p> <p>0=timeout; 1=no timeout</p>
--	--

<p>33 ALRM SND TIMEOUT</p>	<p>Alarm Bell Timeout UL installations = 1 (4 min) minimum</p> <p><input type="checkbox"/> † [1]</p> <p>0 = none; 1=4 min; 2=8 min; 3=12 min; 4 = 16 min</p>
--	--

<p>34 EXIT DELAY TIME</p>	<p>Exit Delay UL installations = 60 seconds max.</p> <p><input type="text"/> <input type="text"/> † [70]</p> <p>00-99 = exit delay time (in seconds)</p>
---	--

<p>35 ENTRY DELAY 1</p>	<p>Entry Delay 1 (zone type 01) UL installations = 45 seconds max.</p> <p><input type="text"/> <input type="text"/> † [30]</p> <p>00-99 = entry delay time (in seconds)</p>
---	---

<p>36 ENTRY DELAY 2</p>	<p>Entry Delay 2 (zone type 02) UL installations = 45 seconds max.</p> <p><input type="text"/> <input type="text"/> † [60]</p> <p>00-99 = entry delay 2 time (in seconds)</p>
---	---

<p>37 EXIT SND/QK EXIT</p>	<p>Audible Exit Warning / Quick Exit</p> <p><input type="checkbox"/> <input type="checkbox"/> † [1, 1]</p> <p>Exit Warn Quick Exit</p> <p>0 = no; 1 = yes</p>
--	---

<p>38 CONF ARMING DING</p>	<p>Confirmation of Arming Ding</p> <p>Note: Confirmation ding only sounds when LYNX is Armed Away or disarmed after being Armed Away. If LYNX is armed by RF button (key fob), a confirmation ding occurs immediately after arming regardless of field *38 settings. If LYNX is disarmed by RF button (key fob), additional disarming confirmation ding occurs immediately after disarming and is longer than arming confirmation ding.</p> <p><input type="checkbox"/> † [0]</p> <p>0 = no arming confirmation ding after arming system by APX32EN keypad or RF keypad; 1 = arming confirmation ding after arming system by APX32EN keypad or RF keypad; 2 = arming confirmation ding after arming from RF keypad only</p>
--	---

<p>39 PUR UP PRV STATE</p>	<p>Power Up In Previous State</p> <p><input type="checkbox"/> † [1]</p> <p>0 = no; 1 = yes; UL installations = 1</p>
--	---

DIALER PROGRAMMING (*40– *53) In fields *40, *41, *42, enter up to the number of digits shown. Enter 0–9; # +11 for '*'; # +12 for '#'; # +13 for a pause.

<p>40 PABX ACCESS CODE</p>	<p>PABX Access Code</p> <p><input type="text"/> <input type="text"/> <input type="text"/> <input type="text"/> <input type="text"/> <input type="text"/></p> <p>Enter 6 digits. If fewer than 6 digits are entered, pressing * advances to the next field. To clear entries from field, press *40*</p>
--	---

† Entering a number other than the one specified may give unpredictable results.

Data Field Display

Function & Programming Options

[] = Programmed Table 1 Default Values

<div style="border: 1px solid black; padding: 5px; text-align: center;"> 41 PRIMARY TEL NUM </div>	<p>Primary Phone Number</p> <div style="display: flex; justify-content: space-between; margin-bottom: 5px;"> </div> <div style="display: flex; justify-content: space-between; margin-bottom: 5px;"> </div> <p>Enter up to 20 digits; Do not fill unused spaces. If fewer than 20 digits entered, pressing *advances to the next field. To clear entries from field, press *41*.</p>
<div style="border: 1px solid black; padding: 5px; text-align: center;"> 42 SECOND TEL NUM </div>	<p>Secondary Phone Number</p> <div style="display: flex; justify-content: space-between; margin-bottom: 5px;"> </div> <div style="display: flex; justify-content: space-between; margin-bottom: 5px;"> </div> <p>Enter up to 24 digits; Do not fill unused spaces. If fewer than 24 digits entered, pressing *advances to the next field. To clear entries from field, press *42*.</p>



All four digits of the subscriber account number must be entered in Fields *43 and *44. If ten digit format is selected in *48 (option 5), all ten digits of the Subscriber Account number must be entered.

In fields *43, *44, enter 4 to 10 digits. Enter 0-9; #+11 for B; #+12 for C; #+13 for D; #+14 for E; [#+15 for F]. Enter * as 4th digit, if 3+1 dialer reporting is to be used. If only 3 digits used, pressing * advances to the next field. Enter [*] as the fifth digit if a 4-digit account number (for 4+1, 4+2, CID®) is used. To clear entries from field, press *43* or *44*.

Examples:

For Acct. **1234**, enter: 1 2 3 4 ; For Acct. **B234**, enter: #+11 2 3 4

For Acct. **1234567890**, enter: 1 2 3 4 5 6 7 8 9 0 ; For Acct. **123**, enter: 1 2 3 *

<div style="border: 1px solid black; padding: 5px; text-align: center;"> 43 PRIMARY ACCOUNT# </div>	<p>Primary Subscriber Account Number</p> <div style="display: flex; justify-content: space-between; margin-bottom: 5px;"> </div> <p>See note above.</p>																			
<div style="border: 1px solid black; padding: 5px; text-align: center;"> 44 SECNDRY ACCOUNT# </div>	<p>Secondary Subscriber Account Number</p> <div style="display: flex; justify-content: space-between; margin-bottom: 5px;"> </div> <p>See note above.</p>																			
<div style="border: 1px solid black; padding: 5px; text-align: center;"> 46 FOLLOW ME PHONE# </div>	<p>“Follow Me” Reminder Phone Number</p> <div style="display: flex; justify-content: space-between; margin-bottom: 5px;"> </div> <div style="display: flex; justify-content: space-between; margin-bottom: 5px;"> </div> <p>Enter up to 24 digits; Do not fill unused spaces. If fewer than 24 digits entered, pressing * advances to the next field. To clear entries from field, press *46*. Enter 0-9, #+11 for '*'; #+12 for '#'; #+13 for a pause (two seconds).</p>																			
<div style="border: 1px solid black; padding: 5px; text-align: center;"> 47 PHONE SYS SELECT </div>	<p>Phone System Select</p> <div style="display: flex; align-items: center; margin-bottom: 5px;"> <input type="checkbox"/> † [5] </div> <div style="border: 1px solid black; padding: 5px; margin-bottom: 5px;"> <p>Note: If you are using Pulse (rotary) Dialing, you must enter the numbers slowly to allow the pulse dialer time to operate.</p> </div> <table border="1" style="width: 100%; border-collapse: collapse; margin-bottom: 5px;"> <thead> <tr> <th rowspan="2">Central Station</th> <th colspan="4">Dialing Mode</th> </tr> <tr> <th>Pulse</th> <th>Tone</th> <th>Pulse</th> <th>Tone</th> </tr> </thead> <tbody> <tr> <td>No WATS</td> <td>0 = No Speaker Phone</td> <td>1 = No Speaker Phone</td> <td>4 = With Speaker Phone</td> <td>5 = With Speaker Phone</td> </tr> <tr> <td>WATS</td> <td>2 = No Speaker Phone</td> <td>3 = No Speaker Phone</td> <td>6 = With Speaker Phone</td> <td>7 = With Speaker Phone</td> </tr> </tbody> </table>	Central Station	Dialing Mode				Pulse	Tone	Pulse	Tone	No WATS	0 = No Speaker Phone	1 = No Speaker Phone	4 = With Speaker Phone	5 = With Speaker Phone	WATS	2 = No Speaker Phone	3 = No Speaker Phone	6 = With Speaker Phone	7 = With Speaker Phone
Central Station	Dialing Mode																			
	Pulse	Tone	Pulse	Tone																
No WATS	0 = No Speaker Phone	1 = No Speaker Phone	4 = With Speaker Phone	5 = With Speaker Phone																
WATS	2 = No Speaker Phone	3 = No Speaker Phone	6 = With Speaker Phone	7 = With Speaker Phone																
<div style="border: 1px solid black; padding: 5px; text-align: center;"> 48 REP FRMT PRI/SEC </div>	<p>Report Format for Primary/Secondary</p> <div style="display: flex; justify-content: space-between; margin-bottom: 5px;"> [7, 7] </div> <div style="display: flex; justify-content: space-between;"> <div style="width: 45%;"> <p>Primary</p> <p>0 = 3+1, 4+1 ADEMCO L/S STANDARD</p> <p>1 = 3+1, 4+1 RADIONICS STANDARD</p> <p>2 = 4+2 ADEMCO L/S STANDARD</p> <p>3 = 4+2 RADIONICS STANDARD</p> <p>5 = ADEMCO CONTACT ID® REPORTING WITH 10-DIGIT SUBS ACCT NO.</p> </div> <div style="width: 45%;"> <p>Secondary</p> <p>6 or undefined = 4+2 ADEMCO EXPRESS</p> <p>7 = ADEMCO CONTACT ID® REPORTING WITH 4-DIGIT SUBS ACCT NO.</p> <p>8 = 3+1, 4+1 ADEMCO L/S EXPANDED</p> <p>9 = 3+1, 4+1 RADIONICS EXPANDED</p> </div> </div> <div style="border: 1px solid black; padding: 5px; margin-top: 5px;"> <p>Note: Option 5 or 7 (ADEMCO Contact ID®) must be selected for AAV.</p> </div>																			

† Entering a number other than the one specified may give unpredictable results.

49 SPLIT/DUAL REP	Split/Dual Reporting <input type="checkbox"/> [0] To Primary Phone No. 0 = All reports 1 = Alarms, Restore, Cancel 2 = All except Open/Close, Test 3 = Alarms, Restore, Cancel 4 = All except Open/Close, Test 5 = All To Primary Phone No. 6 = All reports except Open/Close 7 = All reports 8 = All reports 9 = All reports except Open/Close To Primary Phone No. 10 = All except Open/Close 11 = All reports 12 = All reports 13 = All except Open/Close ‡ Will report users 0, 5-8 or wireless arm/disarm button zones 26-33; all other zones and users do not report. To Secondary Phone No. None, unless primary fails, then all Others Open/Close, Test All All All To Paging Number Alarms, Open/Close‡, Troubles Alarms, Troubles Alarms, Open/Close‡, Troubles Alarms, Troubles To Follow Me System Phone Number) Alarms, Open/Close‡, Troubles Alarms, Troubles Alarms, Open/Close‡, Troubles Open/Close‡
50 15 SEC DIAL DLY	15 Second Dialer Delay (Burglary) UL installations = 0 <input type="checkbox"/> † [0] 0 = no; 1 = yes;
51 PERIOD TEST REP	Periodic Test Report (enter Test Code in field *64) <input type="checkbox"/> † [0] 0 = none; 1 = 24 hours; 2 = weekly; 3 = 30 days
52 TEST REP OFFSET	First Test Report Offset <input type="checkbox"/> † [2] 0 = 24 hour; 1 = 6 hours; 2 = 12 hours; 3 = 18 hours
53 SESCOA/RADIONICS	SESCOA/Radionics Select <input type="checkbox"/> [0] 0 = Radionics (0-9, B-F reporting); 1 = SESCOA (0-9 only reporting). Select 0 for all other formats.
54 LACK OF USAGE	Lack of Usage Notification <input type="checkbox"/> [0] 0 = Disabled 2 = 7 days 3 = 27 4 = 90 days 6 = 365 days 1 = 1 day days 5 = 180 days
55 REPORT CHANNELS	Reporting Channels <input type="checkbox"/> [0] 0 = Telco Line (no Radio) 1 = LRR/IP (Digital Communication only) and Telco Line 3 = LRR/IP (Digital Communication only) (no Telco Line) 5 = LRR/IP (Digital Communication with AAV) (Telco Line connections for 2-way voice session only, if applicable)
58 RF JAM DETECTION	RF Jam Detection Note: For event logging option 2 must be selected. <input type="checkbox"/> [0] 0 = no RF Jam Detection; 1 = RF Jam Detect on, no CS report; 2 = RF Jam Detect on with CS report (if trouble/restore report is enabled in fields *60, *71)

† Entering a number other than the one specified may give unpredictable results.

TO PROGRAM SYSTEM STATUS, & RESTORE REPORT CODES (*59–*76, & *89):

With a 3+1 or 4+1 Standard Format: Enter a code in the *first* box: 1–9, 0, B, C, D, E, or F. Enter "#+10" for 0, "#+11" for B, "#+12" for C, "#+13" for D, "#+14" for E, "#+15" for F.

A "0" (not "#+10") in the *first* box will disable a report.

A "0" (not "#+10") in the *second* box will result in automatic advance to the next field when programming.

With an Expanded or 4+2 Format: Enter codes in *both* boxes (1st and 2nd digits) for 1–9, 0, or B–F, as described above.

A "0" (not "#+10") in the *second* box will eliminate the expanded message for that report.

A "0" (not "#+10") in *both* boxes will disable the report.

With ADEMCO Contact ID Reporting: Enter any digit (other than "0") in the *first* box, to enable zone to report (entries in the *second* boxes will be ignored).

A "0" (not "#+10") in the *first* box will disable the report.

Examples: For Code **3** (single digit), enter:

For Code **3 2** (two digits), enter:

For Code **B 2** (Hexadecimal), enter:

SYSTEM STATUS REPORT CODES (*59–*68)

59 EXIT ERROR REP	Exit Error Report Code <input type="checkbox"/> [1]	2nd digit is automatically sent as 2nd digit of the zone alarm report code programmed in *56, if expanded or 4+2 reporting is selected.
60 TROUBLE REP CODE	Trouble Report Code <input type="text"/> <input type="text"/> [1,0]	
61 BYPASS REP CODE	Bypass Report Code <input type="text"/> <input type="text"/> [0,0]	
62 AC LOSS REP CODE	AC Loss Report Code <input type="text"/> <input type="text"/> [0,0]	
63 LOW BAT REP CODE	Low Bat Report Code <input type="text"/> <input type="text"/> [1,0]	
64 TEST REPORT CODE	Test Report Code <input type="text"/> <input type="text"/> [1,0]	(†† 2nd digit is automatically sent as the user number if expanded or 4+2 reporting is selected.)
65 OPEN REPORT CODE	Open Report Code <input type="checkbox"/> †† [0]	
66 AWAY/STAY REPORT	Arm Away/Stay Report Code <input type="checkbox"/> <input type="checkbox"/> †† [0,0] AWAY STAY	
67 RF TRANS LB REP	RF Transmitter Low Battery Report Code <input type="text"/> <input type="text"/> [1,0]	
68 CANCEL REP CODE	Cancel Report Code <input type="text"/> <input type="text"/> [1,0]	2nd digit is automatically sent as 2nd digit of the zone alarm report code programmed in *56, if expanded or 4+2 reporting is selected.

RESTORE REPORT CODES (*70–*76)

70 ALARM RES REPORT	Alarm Restore Report Code <input type="checkbox"/> [1]
71 TROUBLE RES REP	Trouble Restore Report Code <input type="text"/> <input type="text"/> [1,0]

Data Field Display

Function & Programming Options [] = Programmed Table 1 Default Values

72
BYPASS RES REP

Bypass Restore Report Code

[0,0]

73
AC RESTORE REP

AC Restore Report Code

[0,0]

74
LO BAT RES REP

Low Bat Restore Report Code

[1,0]

75
RF LOBAT RES REP

RF Transmitter Low Battery Restore Report Code

[1,0]

76
TEST RES REPORT

Test Restore Report Code

[0,0]

DYNAMIC SIGNALING FIELD (*77)

77
DYNAMIC SIG OPTS

Dynamic Signaling Options

[0, 0]

1st Entry (delay before switch CS reporting path)

- | | | | |
|---|-----------------|-------------------|-------------------|
| 0 = Redundant reporting on dialer and LRR/IP device | 3 = 45 seconds | 8 = 120 seconds | #13 = 195 seconds |
| 1 = 15 seconds | 4 = 60 seconds | 9 = 135 seconds | #14 = 210 seconds |
| 2 = 30 seconds | 5 = 75 seconds | #10 = 150 seconds | #15 = 225 seconds |
| | 6 = 90 seconds | #11 = 165 seconds | |
| | 7 = 105 seconds | #12 = 180 seconds | |

2nd Entry

- | | | |
|--------------------------------------|------------------------------|---------------------------|
| 0 = Primary Dialer Preferred Channel | 1 = LRR/IP Preferred Channel | 2 = LRR/IP reporting only |
|--------------------------------------|------------------------------|---------------------------|

78
PROG TONE GEN TM

Programmable Tone Generation Time

[0, 0]

00 = Disabled; 01-09 = 100-900 ms; 10-99 = 1.0 – 9.9 secs

OUTPUT AND SYSTEM SETUP (*80, *81, *83–*85) See Procedures later in this manual.

86
MULTI-MODE EMAIL

Multi-Mode (E-Mail Notification)

[0]

0 = Disable multi-mode devices; 1 = Enable multi-mode device address #6 only; 2 = Enable multi-mode device address #7 only; 3 = Enable multi-mode addresses

87
AUX FUNC 1BTN PG

Aux Function/ 1-Button Paging

[0]

0 = Aux key performs defined function (macro);
1 = Aux key sends message to pager or voice message to follow me system phone number.
If 1, you must also select an option 6-9 in field *49 for the pager or 10-13 for the follow me system announcement.

88
PAGER CHARACTERS

Pager Characters

Up to 16 digits can be entered that will appear in front of the 7-digit pager message sent by the control. Refer to the Installation Instructions (fields *87, *88 and *49) for full descriptions of the paging feature. You do not need to fill all 16 digits (press [*] to advance to next field).

To clear entries, enter *88*. To enter "*" = [#] + [11]; To enter "#" = [#] + [12]; To enter 2-second pause = [#] + [13] (some pagers require an additional delay [pause] in order to receive the entire message)

89 EVNT LOG 80% REP	Event Log 80% Full Report Code <input type="text"/> <input type="text"/> [0,0]
90 EVNT LOG OPTIONS	Event Logging Note: System messages are logged when any non-zero selection is made. <input type="checkbox"/> [3] 0 = None; 1 = Alarm/Alarm Restore; 2 = Trouble/Trouble Restore; 4 = Bypass/Bypass Restore; 8 = Open/Close. <i>Example:</i> To select "Alarm/Alarm Restore", and "Open/Close", enter 9 (1 + 8); To select all, enter #15.
91 AAV/REM PHN CTRL	Alarm Audio Verification (AAV)/Remote Phone Control <input type="checkbox"/> [2] 0 = None 1 = AAV and remote phone control 2 = remote phone control only 4 = AAV only Notes: (1) In order to activate the Remote Phone Control feature and defeat an answering machine, ensure that the correct ring detection count ("15") has been programmed in field *:95. (2) Remote phone session will be terminated if a report must be sent. (3) Alarm Audio Verification will only function when Contact ID® is selected. AAV cannot be used for UL installations. (4) If an alarm will be reported to primary and secondary phone numbers, AAV can only function via the secondary number. (5) If an alarm will be reported to a follow me phone number (10-12 in field *:49) AAV cannot be used. (6) If AAV is selected and LRR/IP communications device is enabled, you must enter "0" (primary dialer preferred channel) as the second entry in Field *:77.
92 # REPS ARMED PER	Number of Reports In Armed Period <input type="text"/> [0] 0 = 10 Alarm/Alarm Restore Reports; 1 = Unlimited (UL installations = 0)
DOWNLOAD INFORMATION (*:93--*:95)	
93 FLEXBLE CALLBACK	Flexible Callback <input type="checkbox"/> [0] 0 = No flexible callback; 1 = Last digit flexible; 2 = Last 2 digits flexible; 3 = Last 3 digits flexible
94 DOWNLOAD PHONE #	Download Phone Number Note: In UL installations, downloading may only be performed if a technician is at the site. <input type="text"/> <input type="text"/> <input type="text"/> <input type="text"/> <input type="text"/> <input type="text"/> <input type="text"/> <input type="text"/> <input type="text"/> <input type="text"/> <input type="text"/> <input type="text"/> <input type="text"/> <input type="text"/> <input type="text"/> <input type="text"/> <input type="text"/> <input type="text"/> <input type="text"/> <input type="text"/> <input type="text"/> Enter up to 20 digits, 0-9; #+11 for '*'; #+12 for '#'; #+13 for a pause. Do not fill unused spaces. If fewer than 20 digits entered, pressing * advances to the next field. To clear entries from field, press *:94*.
95 RING DET COUNT	Ring Detection Count for Downloading/Remote Phone Control Mode <input type="text"/> [15] 0 = Disable Station Initiated Download 1-14 = number of rings (1-9, [#]+10 = 10, [#] + 11 = 11, [#] + 12 = 12, [#] + 13 = 13, [#] + 14 = 14); 15 = answering machine defeat ([#] + 15 = 15)

*56 ENHANCED ZONE PROGRAMMING PROCEDURE

This interactive menu mode is used to program zone numbers, zone types, alarm and report codes, and to identify the type of loop input device and can be used for entering 5800 Series transmitter serial numbers. Press *56 while in programming mode.

Note: Entering a number other than the one specified may give unpredictable results.

<p>AO1 ZONE NUMBER</p>	<p>Zone Number Enter the 2-digit zone number to be programmed. The system will announce the Voice Descriptor for the selected zone, if it is programmed.</p> <p>00 = exit zone programming mode 92 = Duress 01 = Hardwire Zone 95, 96, 99 = Panic zones 2-25 = RF transmitter zones (only) [*] = Continue 26-41 = RF button zones (only)</p>
<p>b ZONE TYPE</p>	<p>Zone Type Enter the 2-digit zone type (zt) for this zone. if 00 is entered, the system will skip to DELETE ZONE PARAMETERS prompt (F)</p> <p>00 = Not Used 10 = Interior with Delay 01 = Entry/Exit #1 14 = Carbon Monoxide 02 = Entry/Exit #2 20 = Arm-Stay 03 = Perimeter 21 = Arm-Away 04 = Interior Follower 22 = Disarm 05 = Trouble Day/Alarm Night 23 = No Alarm Response 06 = 24 Hr Silent 24 = Silent Burglary 07 = 24 Hr Audible [*] = Continue 08 = 24 Hr Aux [#] = Return to previous prompt 09 = Fire without Verification</p>
<p>C REPORT CODE</p>	<p>Report Code Enter the Report Code (rc) for this zone. Report consists of 2 hexadecimal digits, each composed of 2 numerical digits. (A = 10, B = 11, C = 12, D = 13, E = 14, F = 15) (see Report Code description for explanation of codes).</p> <p>[*] = Continue; If this is zone 95, 96 or 99, the system skips to the VOICE DESCRIPTOR prompt (1C) [#] = Return to previous prompt</p>
<p>d INPUT TYPE</p>	<p>Input Type Enter the input type (i) for the transmitter assigned to this zone.</p> <p>Note: Zones 2-25 should be assigned as Input Type 3 or 4 and Zones 26-41 should be assigned as Type 5 only.</p> <p>3 = Supervised RF (RF) [*] = Continue 4 = Unsupervised RF (UR) [#] = Return to previous prompt 5 = Button type (BR)</p>
<p>E LOOP#/AUTO LEARN</p>	<p>Loop Number or Loop & Serial Number (if using RF Learning)</p> <p>RF Learning – For BR type devices (device type 5), two (2) transmissions (two key depressions at least five seconds apart) are required. Two beeps will sound after the second transmission, confirming that the loop number and serial number have been learned. For RF and UR device types (device type 3 and 4), four (4) transmissions are required (fault, restore and fault, restore). A single beep will sound after the second transmission confirming that the loop and serial number have been captured. Following the fourth transmission the system will confirm that the loop and serial number have been learned by announcing the Voice Descriptor for the zone, if it is programmed, followed by two beeps.</p> <p>Note: There is a 52-second time-out for RF enrolling. At the end of the time-out, the system returns to the INPUT TYPE prompt (d). If enrolled, loop number and “LEARNED” will be displayed.</p>

*56 ENHANCED ZONE PROGRAMMING PROCEDURE

	<p>Loop Number or Loop & Serial Number (if using RF Learning) (Continued)</p> <p>Manual Entry - Enter the desired loop number and press [*:] to continue (see the transmitter's Installation Instructions for specific loop designations). If "LEARNED" is displayed, the zone's serial number has already been enrolled.</p> <p>Note: The loop number can be changed even if the zone has already been entered. Care should be taken when using this feature. It is possible to make zones inoperable by creating a mismatch of a working serial number/loop number combination. This should be re-confirmed if the loop number is changed.</p> <p>1-4 = Loop number for the zone of the transmitter being entered or learned 0 + [*:] = Delete Serial Number prompt (F) [*:] = Continue to the ENROLL MODE prompt (1A) if not enrolled, or VOICE DESCRIPTOR prompt (1C) if already enrolled. [#] = Return to previous prompt</p>
<div style="border: 1px solid black; padding: 5px; width: fit-content; margin: auto;"> <p>F DELETE ZONE</p> </div>	<p>Delete Zone Parameters</p> <p>If 00 was entered in the Zone Type field or if 0 was entered in the Loop Number field, confirmation of the delete request will delete all information associated with zone currently being programmed.</p> <p>Note: 00 was entered as a zone type in prompt (b), 00 will be retained and system will advance to prompt (1C).</p> <p>0 = Discard the delete request. 1 = Confirm the requested delete.</p>
<div style="border: 1px solid black; padding: 5px; width: fit-content; margin: auto;"> <p>1A ENROLL MODE</p> </div>	<p>Enroll Mode</p> <p>Confirm, delete or enter Serial Number</p> <p>0 = Skip to the VOICE DESCRIPTOR prompt (1C). If zone type is "00", then skips to DELETE SERIAL NUMBER prompt instead.</p> <p>1 = Enroll now and proceed to SERIAL NUMBER prompt (1b) (If "LEARNED" is not displayed).</p> <p>2 = Copy the last serial number from the local memory buffer (If "LEARNED" is not displayed).</p> <p>9 = Delete existing serial number. (Only if "LEARNED" is displayed).</p> <p>[*:] = Advance to the VOICE DESCRIPTOR prompt (1C). This will save all zone parameters.</p> <p>[#] = Return to the loop number prompt (E).</p>
<div style="border: 1px solid black; padding: 5px; width: fit-content; margin: auto;"> <p>1b SERIAL NUMBER</p> </div>	<p>Serial Number</p> <p>Manually enter the 7-digit serial number printed on the transmitter. If an incorrect digit is entered, press the [#] key to return to prompt (1A). When all 7 digits are entered, press the [*:] key. The serial number will be copied into EEROM and the local memory buffer and the system will return to the (1A) prompt and "LEARNED" will be displayed. If 52 seconds pass and no entry is been made, the system will return to prompt (1A).</p> <p>Note: In order for all parameters to be accepted, you must advance to prompt (1C).</p>
<div style="border: 1px solid black; padding: 5px; width: fit-content; margin: auto;"> <p>1C ZONE DESCRIPTOR</p> </div>	<p>Voice Descriptor</p> <p>0 = Skip to next zone (A) 1 = Enter descriptor mode (existing zone descriptor will be announced, then descriptor 1 will be repeated)</p>
<div style="border: 1px solid black; padding: 5px; width: fit-content; margin: auto;"> <p>1d</p> </div>	<p>Descriptor 1</p> <p>Enter [#] + 2-digit vocabulary index† number of first descriptor word for this zone. To change the entered index number, press [#] + desired index number.</p> <p>6 = accept word and advance to descriptor 2 (descriptor 2 will be announced) 8 = accept word and advance to next zone (prompt A) – zone descriptor will be announced</p> <p>Press any other key to repeat the selected word</p>
<p>Note: System displays 2-digit selection & alpha descriptor OR 99 "No selection"</p>	

*56 ENHANCED ZONE PROGRAMMING PROCEDURE

1E

Note: System displays 2-digit selection & alpha descriptor OR 99 "No selection"

Descriptor 2

Enter [#] + 2-digit vocabulary index† number of second descriptor word for this zone. To change the entered index number, press [#] + desired index number.

6 = accept word and advance to descriptor 3 (descriptor 3 will be announced)

8 = accept word and advance to next zone (prompt A) – zone descriptor will be announced

Press any other key to repeat the selected word

1F

Note: System displays 2-digit selection & alpha descriptor OR 99 "No selection"

Descriptor 3

Enter [#] + 2-digit vocabulary index† number of third descriptor word for this zone. To change the entered index number, press [#] + desired index number.

6 or 8 = accept word and advance to next zone (prompt A) – zone descriptor will be announced

Press any other key to repeat the selected word

† See *84 ASSIGN ZONE VOICE DESCRIPTORS section for Vocabulary Index.

*56 ENHANCED ZONE PROGRAMMING WORKSHEET

Fill in the required data on this worksheet, then follow the programming procedure.

ZONES ON CONTROL: See explanation of headings (defaults shown are for Table 1)

Zone Description	Zone No. (A 01)	Zone Type (zt)	Alarm rpt code (hex) (rc)	Vocabulary Index
Wired Zone 1	0 1	[00]	[00 00]	
Duress	9 2	--	[01 00]	
Keypad Panic (1 & *)	9 5	[00]	[00 00]	
Keypad Panic (3 & #)	9 6	[00]	[00 00]	
Keypad Panic (* & #)	9 9	[06]	[01 00]	

Zone No. (A 01)	Zone Type (zt)	Alarm Report Code in hex (rc)	Input Type (i)	Loop No. (l)	Transmitter Serial Number	Vocabulary Index
0 2	[01]	[01 00]	[3]	[2]		[47-04-99]
0 3	[01]	[01 00]	[3]	[2]		[33-04-99]
0 4	[03]	[01 00]	[3]	[2]		[80-99-99]
0 5	[10]	[01 00]	[3]	[1]		[56-99-99]
0 6						
0 7						
0 8						
0 9						
1 0						
1 1						
1 2						
1 3						
1 4						
1 5						
1 6						
1 7						
1 8						
1 9						
2 0						
2 1						
2 2						
2 3						
2 4						
2 5						

*56 ENHANCED ZONE PROGRAMMING WORKSHEET

Button Zones

Zone No. (A 01)	Zone Type (zt)	Alarm Report Code in hex (rc)	Input Type (i)	Loop No. (l)	Transmitter Serial Number	Vocabulary Index
2 6	<input type="text"/> <input type="text"/> [21]	<input type="text"/> <input type="text"/> [01 00]	<input type="text"/> [5]	<input type="text"/> [3]	<input type="text"/>	<input type="text"/> <input type="text"/>
2 7	<input type="text"/> <input type="text"/> [22]	<input type="text"/> <input type="text"/> [01 00]	<input type="text"/> [5]	<input type="text"/> [2]	<input type="text"/>	<input type="text"/> <input type="text"/>
2 8	<input type="text"/> <input type="text"/> [20]	<input type="text"/> <input type="text"/> [01 00]	<input type="text"/> [5]	<input type="text"/> [4]	<input type="text"/>	<input type="text"/> <input type="text"/>
2 9	<input type="text"/> <input type="text"/> [23]	<input type="text"/> <input type="text"/> [00 00]	<input type="text"/> [5]	<input type="text"/> [1]	<input type="text"/>	<input type="text"/> <input type="text"/>
3 0	<input type="text"/> <input type="text"/> [21]	<input type="text"/> <input type="text"/> [01 00]	<input type="text"/> [5]	<input type="text"/> [3]	<input type="text"/>	<input type="text"/> <input type="text"/>
3 1	<input type="text"/> <input type="text"/> [22]	<input type="text"/> <input type="text"/> [01 00]	<input type="text"/> [5]	<input type="text"/> [2]	<input type="text"/>	<input type="text"/> <input type="text"/>
3 2	<input type="text"/> <input type="text"/> [20]	<input type="text"/> <input type="text"/> [01 00]	<input type="text"/> [5]	<input type="text"/> [4]	<input type="text"/>	<input type="text"/> <input type="text"/>
3 3	<input type="text"/> <input type="text"/> [23]	<input type="text"/> <input type="text"/> [00 00]	<input type="text"/> [5]	<input type="text"/> [1]	<input type="text"/>	<input type="text"/> <input type="text"/>
3 4	<input type="text"/> <input type="text"/>	<input type="text"/> <input type="text"/>	<input type="text"/>	<input type="text"/>	<input type="text"/>	<input type="text"/> <input type="text"/>
3 5	<input type="text"/> <input type="text"/>	<input type="text"/> <input type="text"/>	<input type="text"/>	<input type="text"/>	<input type="text"/>	<input type="text"/> <input type="text"/>
3 6	<input type="text"/> <input type="text"/>	<input type="text"/> <input type="text"/>	<input type="text"/>	<input type="text"/>	<input type="text"/>	<input type="text"/> <input type="text"/>
3 7	<input type="text"/> <input type="text"/>	<input type="text"/> <input type="text"/>	<input type="text"/>	<input type="text"/>	<input type="text"/>	<input type="text"/> <input type="text"/>
3 8	<input type="text"/> <input type="text"/>	<input type="text"/> <input type="text"/>	<input type="text"/>	<input type="text"/>	<input type="text"/>	<input type="text"/> <input type="text"/>
3 9	<input type="text"/> <input type="text"/>	<input type="text"/> <input type="text"/>	<input type="text"/>	<input type="text"/>	<input type="text"/>	<input type="text"/> <input type="text"/>
4 0	<input type="text"/> <input type="text"/>	<input type="text"/> <input type="text"/>	<input type="text"/>	<input type="text"/>	<input type="text"/>	<input type="text"/> <input type="text"/>
4 1	<input type="text"/> <input type="text"/>	<input type="text"/> <input type="text"/>	<input type="text"/>	<input type="text"/>	<input type="text"/>	<input type="text"/> <input type="text"/>

EXPLANATION OF ZONE ASSIGNMENT TABLE HEADINGS

A 01 = ZONE No. Zone Numbers are 01 (wired), 02-25 (RF) only, 26-41 (Button) only, 92 (duress), 95, 96, 99 (panic)

zt = ZONE TYPE

- | | |
|------------------------------|--------------------------------|
| 00 = Not Used | 09 = Fire without Verification |
| 01 = Entry/Exit #1 | 10 = Interior with Delay |
| 02 = Entry/Exit #2 | 14 = Carbon Monoxide |
| 03 = Perimeter | 20 = Arm-Stay |
| 04 = Interior Follower | 21 = Arm-Away |
| 05 = Trouble Day/Alarm Night | 22 = Disarm |
| 06 = 24 Hr Silent | 23 = No Alarm Response |
| 07 = 24 Hr Audible | 24 = Silent Burglary |
| 08 = 24 Hr Aux | |

rc = ALARM REPORT CODE

Two Hex Digits. For each Hex Digit, enter: 00-09 for 0-9, 10 for A, 11 for B, 12 for C, 13 for D, 14 for E, 15 for F. If "00" is entered as the first digit, there will be no report for that zone.

For Contact ID reporting, this is enabling code only. Enter any hex digit (other than 00) in the first pair of boxes. The second pair of boxes is ignored.

i = INPUT TYPE

Enter 3 for RF: Supervised RF
Enter 4 for UR: Unsupervised RF
Enter 5 for BR: Button Type RF

Zones 2-25 should be assigned as Input Type 3 or 4 and Zones 26-41 should be assigned as Type 5 only.

l = LOOP NUMBER

Used with 5800 RF Loop Input Devices. Record transmitter loop number. Entries are 1-4, depending on device being used. Refer to the transmitter's instructions for appropriate loop numbers.

*80 DEVICE PROGRAMMING

Use this mode to program Powerline Carrier Devices or zone lists for Chime by Zone feature. It is also used to program the Remote Services Multi-mode (e-mail) event triggers. Press *80 while in programming mode.

Note: Entering a number other than the one specified may give unpredictable results.

80 DEVICE PROG MENU	Powerline Carrier Device Programming 0 = Exit mode, upon which this prompt blinks. 1 = Enter mode
801 DEVICE NUMBER	Device Number Enter the 2-digit device number to be programmed 01-08 = X10 device number 09-16 = Multimode (e-mail) event triggers [*] = Continue 00 = Exit Device Programming mode (displays blinking 80; enter * + desired data field or menu mode number)
b DEVICE ACTION	Device Action Enter the 1-digit action, 0-3, for the device being programmed (current action is displayed). 0 = No response 1 = Close for 2 seconds 2 = Close and stay closed 3 = Pulse on and off [*] = Continue [#] = Return to previous prompt
Ɛ START EVENT TYPE	Start Event Type (If applicable) Enter the 1-digit start event type, 0-3, for the device being programmed. 0 = Not used 1 = Alarm 2 = Fault 3 = Trouble [*] = Continue [#] = Return to previous prompt
d START ZONE LIST	Start Zone List (If applicable) Enter the 1-digit zone list number, 1-3, or 0 if not used, for the device being programmed. [*] = Continue [#] = Return to previous prompt
E START ZONE TYPE	Start Zone Type (If applicable) Enter the 2-digit start zone type for the device being programmed (see Powerline Carrier Device Worksheet for zone type/system operation codes later in this manual). [*] = Continue [#] = Return to previous prompt
F STOP ZONE LIST	Stop Zone List (If applicable) Enter the 1-digit zone list number, 1-3, or 0 if not used, for the device being programmed. [*] = Continue [#] = Return to previous prompt
1A STOP ZONE TYPE	Stop Zone Type (If applicable) Enter the 2-digit stop zone type for the device being programmed (see Powerline Carrier Device Worksheet for zone type/system operation codes later in this manual). [*] = Continue to Device Number prompt (A) [#] = Return to previous prompt

*81 ZONE LISTS

Use this mode to define zone lists for Powerline Carrier Devices and/or for the chime by zone feature. Press *81 while in programming mode.

Note: Entering a number other than the one specified may give unpredictable results.

<p>81 ZONE LISTS MENU</p>	<p>Zone List Programming 0 = Exit mode, upon which this prompt blinks. 1 = Enter mode</p>
<p>801 ZONE LIST NUMBER</p>	<p>Zone List Number 2-digit zone list number to be programmed (use zone list 03 for chime by zone feature). 00 = No zone list, exit zone list mode 01, 02 or 03 = Zone List Number [*] = Accept zone number and enter the next zone number</p>
<p>b ZN ENTRY TO LIST</p>	<p>Zone Entry To List Enter the 2-digit zone number to be added to this zone list. The system will announce the Voice Descriptor for the selected zone, if it is programmed. [*] = Accept zone number and enter the next zone number 00 = Accept zone number and continue to next prompt</p>
<p>C DEL WHOLE ZN LST</p>	<p>Delete Entire Zone List 0 = Don't delete; continue to next prompt 1 = Delete the current zone list</p>
<p>d DEL 1 ZN FRM LST</p>	<p>Delete Zones From List? 0 = Don't delete; continue to next zone list number (prompt A) 1 = Continue to delete zones prompt</p>
<p>E DELETE ZONES</p>	<p>Delete Zones Enter the 2-digit zone number to be deleted from the current zone list. When deleting a zone(s) from the zone list, if the selected zone has a Voice Descriptor programmed, upon deletion it will be announced as a confirmation that it has been deleted. [*] = Delete zone and enter next zone to be deleted 00 = Return to next zone list number (prompt A 01)</p>

POWERLINE CARRIER DEVICES WORKSHEET FOR *80 and *81

Applicable only if Powerline Carrier Devices are to be used, or chime-by-zone feature is used.

UL Powerline Carrier Devices have not been evaluated by UL.

*80 OUTPUT DEVICES

Fill in the required data on the worksheet on below and follow the programming procedure in the Installation Instructions as you enter the data during the displays and prompts that appear in sequence.

Note: If using P.C.L.D. (X10 devices), Field *25 must be programmed with a House Code.

DEVICE NUMBER	ACTION (aa)	START			STOP	
		EVENT TYPE (et)	ZONE LIST (zl)	ZONE TYPE SYS OPERATION (zt)	either or both	
		either or both			RESTORE ZONE LIST (zl)	ZONE TYPE/SYS OPERATION (zt)
P.L.C.D.*† 01						
P.L.C.D.*† 02						
P.L.C.D.*† 03						
P.L.C.D.* 04						
P.L.C.D.* †05						
P.L.C.D.*† 06						
SYS. P.L.C.D.*† 07						
SYS. P.L.C.D.*† 08	[2]			[33]		[36]
E-mail event trigger 09						
E-mail event trigger 10						
E-mail event trigger 11						
E-mail event trigger 12						
E-mail event trigger 13						
E-mail event trigger 14						
E-mail event trigger 15						
E-mail event trigger 16	[2]			[33]		[36]

Note: If using an X10 Powerhouse Security SH10A Siren as device 08, you must change the action default to "3" if using default table 4.

Where:	A = DEVICE ACTION	0 = No Response; 1 = Close for 2 sec; 2 = Close and stay closed; 3 = Pulse on and off.																														
	ET = EVENT TYPE	0 = Not used; 1 = Alarm; 2 = Fault; 3 = Trouble.																														
	ZL = ZONE LIST	1, 2, or 3 (from Field *81) or 0 = Not Used. "START" ZONE LIST: Upon alarm, fault, or trouble of ANY zone on this list, device action will START. "STOP" RESTORE of ZONE LIST: Upon restore of ALL zones on this list, device action will STOP. It need not be same list as used for START. Note: Do not assign zones with types 20, 21, or 22 to a zone list.																														
	ZT = ZONE TYPE/ SYSTEM OPERATION	<p>Choices for Zone Types are:</p> <table border="0"> <tr> <td>00 = Not Used</td> <td>05 = Trouble Day/Alarm Night</td> <td>09 = Fire Zone without Verification</td> </tr> <tr> <td>01 = Entry/Exit#1</td> <td>06 = 24 Hour Silent</td> <td>10 = Interior with Delay</td> </tr> <tr> <td>02 = Entry/Exit#2</td> <td>07 = 24 Hour Audible</td> <td>14 = Carbon Monoxide</td> </tr> <tr> <td>03 = Perimeter</td> <td>08 = 24 Hour Aux</td> <td>24 = Silent Burglary</td> </tr> <tr> <td>04 = Interior Follower</td> <td></td> <td></td> </tr> </table> <p>Note: Any zone in "ZT" going into alarm, fault, or trouble will activate device with the exception of 01, 02 when the system is in alarm. Any zone that restores will stop device action.</p> <p>Choices for System Operation are:</p> <table border="0"> <tr> <td>20 = Arming-Stay</td> <td>33 = Any Alarm (except ZT=08 or 09)</td> <td>40 = Bypassing</td> </tr> <tr> <td>21 = Arming-Away</td> <td>36 = *At Bell Timeout</td> <td>42 = System Battery Low</td> </tr> <tr> <td>22 = Disarming (Code + FF)</td> <td>38 = Chime</td> <td>43 = Communication Failure</td> </tr> <tr> <td>31 = End of Exit Time</td> <td>39 = Any Fire Alarm</td> <td>52 = KISSOFF</td> </tr> <tr> <td>32 = Start of Entry Time</td> <td>* Or at Disarming, whichever occurs earlier.</td> <td>58 = Duress</td> </tr> </table>	00 = Not Used	05 = Trouble Day/Alarm Night	09 = Fire Zone without Verification	01 = Entry/Exit#1	06 = 24 Hour Silent	10 = Interior with Delay	02 = Entry/Exit#2	07 = 24 Hour Audible	14 = Carbon Monoxide	03 = Perimeter	08 = 24 Hour Aux	24 = Silent Burglary	04 = Interior Follower			20 = Arming-Stay	33 = Any Alarm (except ZT=08 or 09)	40 = Bypassing	21 = Arming-Away	36 = *At Bell Timeout	42 = System Battery Low	22 = Disarming (Code + FF)	38 = Chime	43 = Communication Failure	31 = End of Exit Time	39 = Any Fire Alarm	52 = KISSOFF	32 = Start of Entry Time	* Or at Disarming, whichever occurs earlier.	58 = Duress
00 = Not Used	05 = Trouble Day/Alarm Night	09 = Fire Zone without Verification																														
01 = Entry/Exit#1	06 = 24 Hour Silent	10 = Interior with Delay																														
02 = Entry/Exit#2	07 = 24 Hour Audible	14 = Carbon Monoxide																														
03 = Perimeter	08 = 24 Hour Aux	24 = Silent Burglary																														
04 = Interior Follower																																
20 = Arming-Stay	33 = Any Alarm (except ZT=08 or 09)	40 = Bypassing																														
21 = Arming-Away	36 = *At Bell Timeout	42 = System Battery Low																														
22 = Disarming (Code + FF)	38 = Chime	43 = Communication Failure																														
31 = End of Exit Time	39 = Any Fire Alarm	52 = KISSOFF																														
32 = Start of Entry Time	* Or at Disarming, whichever occurs earlier.	58 = Duress																														

Note: In normal operation mode:

For Devices 01-06: Function + Lights On + NN
 For Devices 07 and 08: Code + Function + Lights On + NN
 NN = 2- digit device number (Entry starts Device NN)
 Code + Function + Lights Off + NN (Entry stops Device NN)

*81 ZONE LISTS FOR OUTPUT DEVICES

Fill in the required data on the worksheet below and follow the procedure in the installation manual as you enter the data during the displays and prompts that appear in sequence.

Zone List 1: Started or stopped by zone numbers (enter 00 to end entries).

etc. [28][32]

Zone List 2: Started or stopped by zone numbers (enter 00 to end entries).

etc. [29][33]

Zone List 3: Started or stopped by zone numbers AND/OR assignment of Chime zones (enter 00 to end entries)

etc. [02][03]

*83 ENHANCED SEQUENTIAL MODE

Use this mode to enter transmitter serial numbers. Press *83 while in programming mode.

83 ENHANCED SEQ MODE	Enhanced Sequential Mode 0 = Exit mode, upon which this prompt blinks. 1 = Enter mode
A ZONE NUMBER	Zone Number Enter the 2-digit zone number of the first transmitter to have its serial number entered. The system will announce the Voice Descriptor for the selected zone if it has been programmed. [*:] = Continue; system searches for zones not yet entered, (for zones 2 to 25 a zone type must be entered) then advances to SERIAL NUMBER prompt (1b). 00 = Exit Sequential mode, upon which the prompt "83" blinks.
1A ENROLL MODE	Enroll Mode Enter, View or Confirm Serial Number. 0 = Advance to next unlearned zone. 1 = Enter now and proceed to SERIAL NUMBER prompt (1b). For 4-button keys (zones 26-29, 30-33, 34-37 and 38-41) the serial number will be learned to all four buttons. 2 = copy the previous serial number entry from the buffer. Note: Before you can copy a serial number you must first enter a serial number. If no serial is stored in the buffer and a copy is attempted the panel will emit a long beep indicating an invalid operation. 3 = View existing serial number. (Only if "L" is displayed. If "L" is not displayed, panel will emit a long beep. Each digit will be displayed and the keypad will beep once for digits 1-6 and three times for last digit. 4 = Copy the 4-button key template set for zones 26 - 29 (includes all zone parameters except serial numbers). Only valid on 4-button key zones 30-33, 34-37 and 38-41 that do not have serial numbers learned. (Template acceptance is indicated by two beeps after copying. A single long beep emitted when copying templates indicates the template is not valid.) 9 = Delete existing serial number. Go to the (1A) prompt. (For 4-button key zones 26-29, 30-33, 34-37 and 38-41, deletes all four at once.) [*:] = Advance to the next unlearned zone. [#] = Return to previous prompt (1A).
1b SERIAL NUMBER	Serial Number Enroll transmitter serial number via RF transmission or manually. RF Learning - Two (2) transmissions (two key depressions) at least five seconds apart will be required for BR type or four (4) transmissions (fault, restore and fault, restore) for UR or RF type. If the learned serial number has a different loop number than that entered in *:56 the system will announce the Voice Descriptor, if it is programmed, followed by two beeps and will return to Prompt (1A) and "LEARNED" will be displayed. If the loop number captured by RF transmission and that entered in *:56 mode match, the system will announce the Voice Descriptor, if it is programmed, followed by three beeps and return to Prompt (1A) and "LEARNED" will be displayed. No additional transmissions are needed for confirmation. Manual Entry - Enter the 7-digit serial number printed on the transmitter. If you enter an incorrect digit, press the [#] key to backup to prompt (1A) and start over. When all 7 digits are entered, press the [*:] key. If less than 7 digits are entered, the keypad will emit a single long beep and return to the (1A) prompt without displaying "LEARNED". If more than 7 digits have been entered, the first 6 digits will be saved along with the last digit that was entered (entering 123456789 yields the serial number 1234569). Note: If 52 seconds passes and no entry has been made, the system returns to prompt (1A).
F DELETE ZONE CONF	Delete Zone Parameters Confirmation 0 = Discard the delete request. 1 = Confirm requested delete.

*84 ASSIGN ZONE VOICE DESCRIPTORS

Use this mode to assign voice descriptors for each zone. These are the descriptors that are announced when the system announces any event involving a zone number. Press *84 while in programming mode.

Note: Entering a number other than the one specified may give unpredictable results.

84 <i>ZONE VOICE DESC</i>	<p>Assign Voice Descriptors</p> <p>0 = Exit mode, upon which this prompt blinks. 1 = Enter mode</p>
A <i>ZONE NUMBER</i>	<p>Zone Number</p> <p>Enter the 2-digit zone number for which this descriptor is being assigned then press [*]. The Voice Descriptor for the selected zone will be announced, if it has been programmed. [*] = Continue to next prompt (existing descriptors will be announced, then descriptor 1 will be repeated.) 00 = Exit Zone Voice Descriptor mode (displays blinking 84; enter * + desired data field or menu mode number)</p>
b <i>DESCRIPTOR 1</i>	<p>Descriptor 1</p> <p>Enter [#] + 2-digit vocabulary index number of first descriptor word for this zone. To change the entered index number, press [#] + desired index number. 6 = accept word and advance to descriptor 2 (descriptor 2 will be announced) 8 = accept word and advance to next zone (prompt A) – zone descriptor will be announced. Press any other key to repeat the selected word</p>
c <i>DESCRIPTOR 2</i>	<p>Descriptor 2</p> <p>Enter [#] + 2-digit vocabulary index number of second descriptor word for this zone. To change the entered index number, press [#] + desired index number. 6 = accept word and advance to descriptor 3 (descriptor 3 will be announced) 8 = accept word and advance to next zone (prompt A) – zone descriptor will be announced. Press any other key to repeat the selected word</p>
d <i>DESCRIPTOR 3</i>	<p>Descriptor 3</p> <p>Enter [#] + 2-digit vocabulary index number of third descriptor word for this zone. To change the entered index number, press [#] + desired index number. 6 or 8 = accept word and advance to next zone (prompt A) – zone descriptor will be announced. Press any other key to repeat the selected word</p>

VOCABULARY INDEX

00 ½ sec pause A 82 ALARM 32 ATTIC B 01 BABY 33 BACK 34 BASEMENT 35 BATHROOM 36 BEDROOM C 83 CHECK D 37 DELAY DOOR 38 DEN 02 DETECTOR 03 DINING 39 DINING ROOM 04 DOOR 40 DOWNSTAIRS 05 DRIVEWAY E 06 EAST 41 EIGHT 42 EMERGENCY	F 43 FAMILY ROOM 87 FIRE 44 FIRE DETECTION 07 FIRST FLOOR 45 FIVE 08 FLOOR 46 FOUR 47 FRONT G 48 GARAGE 49 GUEST ROOM 09 GUN H 50 HALL I 10 INSIDE K 51 KITCHEN L 11 LAUNDRY 52 LAUNDRY ROOM 12 LIBRARY 13 LIVING 53 LIVING ROOM	M 14 MAIN 15 MASTER 54 MASTER BEDROOM 55 MEDICAL 84 MESSAGE 56 MOTION DETECTOR N 57 NINE 16 NORTH 58 NURSERY O 59 OFFICE 60 ONE 17 OUTSIDE P 61 PATIO 62 POLICE 18 POOL R 63 REAR 19 ROOM	S 64 SECOND FLOOR 65 SEVEN 20 SHED 21 SHOP 66 SIDE 67 SILENT POLICE 68 SIX 69 SLIDING 22 SMOKE 23 SOUTH 24 STORAGE 85 SYSTEM T 25 THIRD FLOOR 75 THREE 76 TRANSMITTER 77 TWO U 78 UPSTAIRS 26 UTILITY 79 UTILITY ROOM W 27 WEST 80 WINDOW Y 28 YARD Z 81 ZERO 86 ZONES	29 1st 30 2nd 31 3rd 70 Custom Word #1 71 Custom Word #2 72 Custom Word #3 73 Custom Word #4 74 Custom Word #5 99 Blank (to erase previously programmed word) SYSTEM WORDS (Announced by system – not programmable) AC LOSS ARMED AWAY BYPASSED CARBON MONOXIDE CHIME DISARMED DISARM SYSTEM NOW EXIT NOW FAULT INSTANT LOW BATTERY NOT READY TO ARM STAY
--	--	--	---	--

Note: If a Wireless Keypad is being installed along with this system, not all the voice descriptors shown on this list can be announced by keypad. (Refer to the Wireless Keypad documentation for further information).











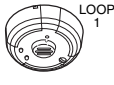
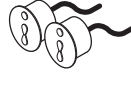
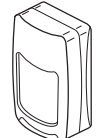
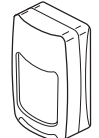
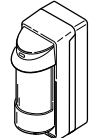
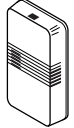

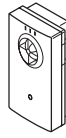
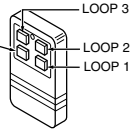

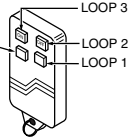
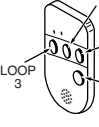
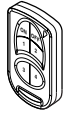
*85 RECORD CUSTOM VOICE DESCRIPTORS

Use this mode to record up to 5 custom voice descriptors for use with zone announcements. Press *85 while in programming mode.

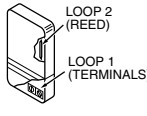
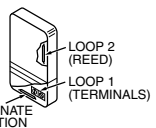
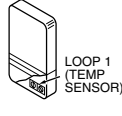
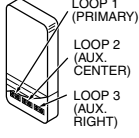
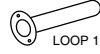
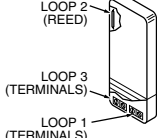
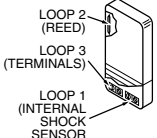
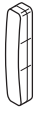
NOTE: Entry of a number other than one specified will give unpredictable results.

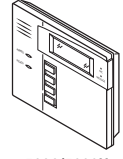
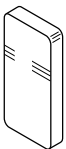
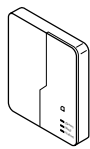
<p>85 REC VOICE DESCR</p>	<p>Record Custom Voice Descriptors 0 = Exit mode, upon which this prompt blinks. 1 = Enter mode</p>
<p>A CUSTOM DESC #</p>	<p>Custom Descriptor Number Enter 7 + <i>d</i> + [*] where <i>d</i> = 0-4, each representing custom word 70, 71, 72, 73 or 74 respectively. Existing descriptor will be announced. Press [#] to start recorder. Begin speaking immediately after the third beep. Speak the desired word clearly near the keypad microphone. Recording stops after 1.5 seconds. 6 = Accept word and ready to record next descriptor (prompt A...7d) [#] = Re-record descriptor 00 = Exit Record mode after pressing 6 (displays blinking 85; enter * + desired data field or menu mode number) Press any other key to repeat the recorded word.</p>

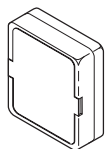
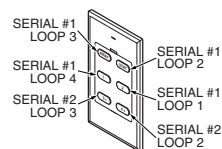
5800 SERIES LOOP NUMBERS

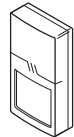
 5800CO ENROLL AS "RF" LOOP 1	 5800Micra ENROLL AS "RF"	 5800PIR-RES ENROLL AS "RF" LOOP 1	 5800PIR/ 5800PIR-COM ENROLL AS "RF" LOOP 1 (LOW SENSITIVITY) LOOP 2 (HIGH SENSITIVITY) LOOP 3 (TEMP) LOOP 4 (TAMPER)	 5800PIR-OD ENROLL AS "RF" LOOP 1 (LOW SENSITIVITY) LOOP 2 (HIGH SENSITIVITY) LOOP 3 (TEMP) LOOP 4 (TAMPER)	 5800RL SET HOUSE ID		
 5800SS1 ENROLL AS "RF"	 5800WAVE PROGRAM HOUSE ID	 5801 ENROLL AS "UR OR "RF" LOOP 1 LOOP 2 LOOP 3 LOOP 4 YOU MUST ENROLL THIS BUTTON	 5802MN ENROLL AS "UR" OR "RF"	 5802MN2 ENROLL AS "UR" OR "RF"	 5804/5804E ENROLL AS "BR" LOOP 1 LOOP 2 LOOP 3 LOOP 4 YOU MUST ENROLL THIS BUTTON	 5804BD/5804BDV ENROLL AS "BR" PROGRAM HOUSE ID LOOP 1 LOOP 2 LOOP 3 LOOP 4 YOU MUST ENROLL THIS BUTTON	
 5805-6 ENROLL AS "BR"	 5806/5806W3/5807 5808/5808LST/5808W3 ENROLL AS "RF" LOOP 1	 5809 ENROLL AS "RF" LOOP 1	 5811 ENROLL AS "RF"	 5814 ENROLL AS "RF" LOOP 1	 5816 ENROLL AS "RF" LOOP 1 (TERMINALS) LOOP 2 (REED)	 5816MN ENROLL AS "RF" LOOP 1 (TERMINALS) LOOP 2 (REED) ALTERNATE POSITION FOR LOOP 2	
 5816TEMP ENROLL AS "RF" LOOP 1 (TEMP SENSOR)	 5817 ENROLL AS "RF" LOOP 1 (PRIMARY) LOOP 2 (AUX. CENTER) LOOP 3 (AUX. RIGHT)	 5818 ENROLL AS "RF" LOOP 1	 5819 ENROLL AS "RF" LOOP 1 (TERMINALS) LOOP 2 (REED) LOOP 3 (TERMINALS)	 5819S (WHS & BRS) ENROLL AS "RF" LOOP 1 (INTERNAL SHOCK SENSOR) LOOP 2 (REED) LOOP 3 (TERMINALS)	 5820/5820L ENROLL AS "RF"	 5821 ENROLL AS "RF"	 5828/5828V PROGRAM HOUSE ID
 5849 ENROLL AS "RF" LOOP 1 (SOUND)	 5850 (GBD) ENROLL AS "RF"	 5853 ENROLL AS "RF"	 5870API ENROLL AS "RF" LOOP 1 (HIGH SECURITY) LOOP 2 (STANDARD SECURITY) LOOP 3 (TILT MODE) LOOP 4 (TAMPER)	 5878 ENROLL AS "BR" SERIAL #1 LOOP 3 SERIAL #1 LOOP 4 SERIAL #2 LOOP 3 SERIAL #1 LOOP 2 SERIAL #2 LOOP 2	 5890/5890PI ENROLL AS "RF" LOOP 1 (MOTION)		
 5894PI ENROLL AS "RF"	 5897 ENROLL AS "RF"						

5800-002-V0

- Notes:** (1) You must enroll loop 4 on the 5801, 5804/5804E, and 5804BD/5804BDV transmitters, regardless of whether it is used or not.
 (2) 5804E encrypted (High-Security) devices must be activated while the system is in Go/No Go Test Mode. Refer to the transmitter's installation instructions for complete details. The system will confirm enrollment of the encrypted device by beeping two times.



The 5800RL, 5802MN, 5802MN2, 5804, 5804BD, 5804BDV, 5804E, 5808LST, 5814, 5816TEMP, 5819, 5819S(WHS & BRS), 5828/5828V and 5850(GBD) transmitters are not intended for any UL installations.

- Notes -

UL INSTALLATIONS THE MINIMUM WIRE SIZE USED FOR TELEPHONE INSTALLATIONS MUST BE #26 GAGE

WARNING TO PREVENT RISK OF SHOCK, DISCONNECT AT TELEPHONE JACK BEFORE SERVICING THIS UNIT

UL EXTERNAL SOUNDERS AND POWERLINE CARRIER DEVICES HAVE NOT BEEN EVALUATED BY UL.

POWER SHUTDOWN NOTE: AT 6.0VDC THE SYSTEM WILL NOT OPERATE.

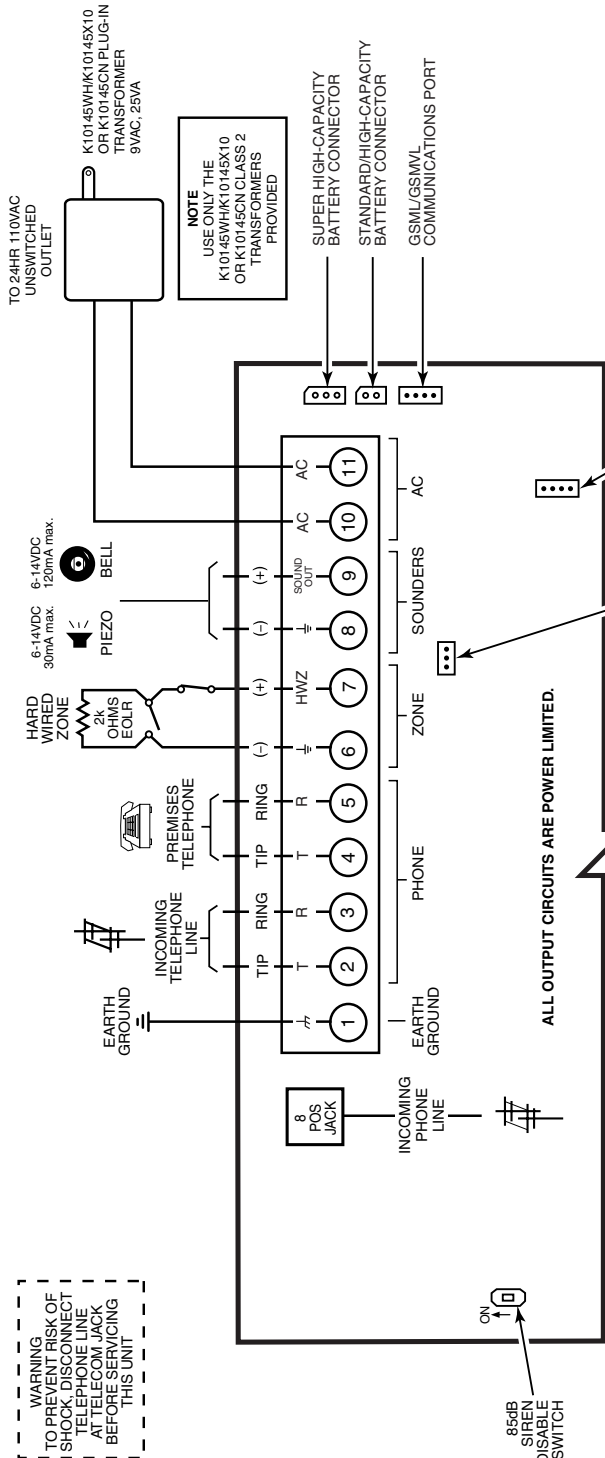

FCC ID: CFS80LLYNXPLUS (LYNX PLUS SERIES) COMPLIES WITH FCC RULES. PART 68 FCC REGISTRATION No. 59BUSA-25623-1A-E FINGER EQUIVALENCE: 0.68

THIS EQUIPMENT SHOULD BE INSTALLED IN ACCORDANCE WITH THE NATIONAL FIRE PROTECTION ASSOCIATION STANDARDS ANSI/NFPA 70 NATIONAL ELECTRIC CODE AND NFPA 72 NATIONAL FIRE ALARM CODE, CHAPTER 2 (NATIONAL FIRE PROTECTION ASSOC., BATTERY MARCH PARK, QUINCY, MA 02169). PRINTED INFORMATION DESCRIBING PROPER INSTALLATION, EVACUATION PROCEDURES AND REPAIR SERVICE IS TO BE PROVIDED WITH THIS EQUIPMENT.

THIS DEVICE COMPLIES WITH PART 15 OF FCC RULES. OPERATION IS SUBJECT TO THE FOLLOWING TWO CONDITIONS: (1) THIS DEVICE MAY NOT CAUSE HARMFUL INTERFERENCE, AND (2) THIS DEVICE MUST ACCEPT ANY INTERFERENCE RECEIVED, INCLUDING INTERFERENCE THAT MAY CAUSE UNDESIRABLE OPERATION.

LYNX PLUS SERIES ALSO COMPLIES WITH THE FOLLOWING: CANADIAN STANDARDS ASSOCIATION (CSA) C22.1, CANADIAN ELECTRICAL CODE, PART 1, SAFETY STANDARD FOR ELECTRICAL INSTALLATIONS AND CANULC-S540 INSTALLATION OF RESIDENTIAL FIRE WARNING SYSTEMS.

THE LYNX PLUS SERIES CONTROLS ARE COMPATIBLE WITH THE FOLLOWING INTEGRAL RECHARGEABLE BATTERY PACKS: P/N LYNXRCHKIT-SC P/N LYNXRCHKIT-HC P/N LYNXRCHKIT-SHA REPLACE EVERY FOUR YEARS

WEEKLY TESTING IS REQUIRED TO ENSURE PROPER OPERATION OF THIS SYSTEM

WARNING
THIS UNIT MAY BE PROGRAMMED TO INCLUDE AN ALARM VERIFICATION FEATURE THAT WILL RESULT IN A DELAY OF THE SYSTEM ALARM SIGNAL FROM THE INDICATED FIRE CIRCUITS. THE TOTAL DELAY (CONTROL UNIT PLUS SMOKE DETECTORS) SHALL NOT EXCEED 60 SECONDS. NO OTHER INITIATING DEVICES SHALL BE CONNECTED TO THESE CIRCUITS UNLESS APPROVED BY THE LOCAL AUTHORITY HAVING JURISDICTION.

CIRCUIT (ZONE)	CONTROL UNIT DELAY-SEC	SMOKE DETECTOR DELAY-SEC
02-25	30 seconds	
ZT16		10 seconds

ALL OUTPUT CIRCUITS ARE POWER LIMITED.

LYNX PLUS SERIES SUMMARY OF CONNECTIONS

Honeywell

2 Corporate Center Drive, Suite 100
P.O. Box 9040, Melville, NY 11747
Copyright © 2009 Honeywell International Inc.

www.honeywell.com/security



800-03859 9/09 Rev. A